

Chapter 17: Electric Potential

The electrostatic force is **conservative** – electric **potential** energy can be defined (just like for gravitational force)

Change in electric potential energy is negative of work done by electric force (independent of path):

In the figure:

$$W = Fd \cos \theta = qEd \cos \phi \Rightarrow PE_b - PE_a = -qEd$$

θ Angle between the electric force and the displacement

ϕ Angle between the electric field and the displacement

Small positive charge q initially at a .

Electric force does work on it and accelerates it toward b . The potential energy decreases and the particle's kinetic energy increases.

Reverse is true for negative charge.

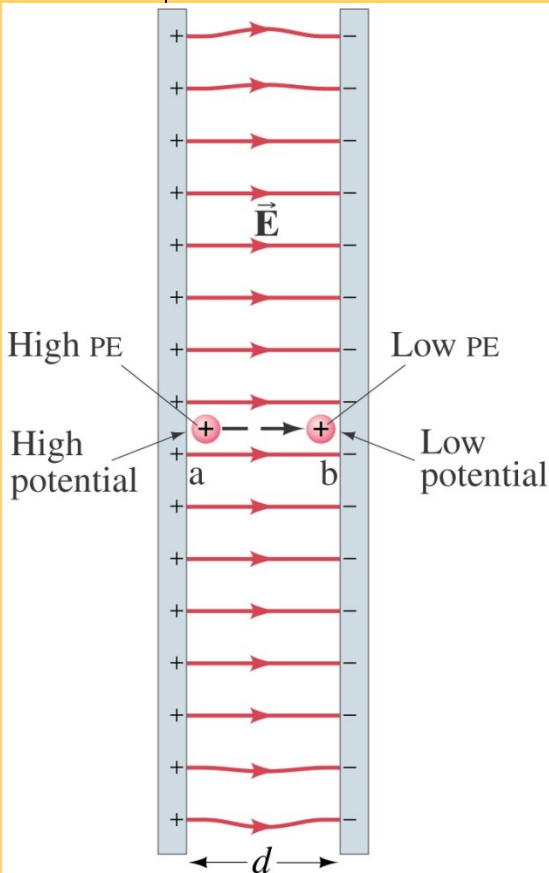

Electric Potential

Similarly to electric field, we define **electric potential** as the potential energy per unit charge:

$$V_a = \frac{PE_a}{q}$$

Unit of electric potential: the volt (V) $1 \text{ V} = 1 \text{ J/C}$.

Only difference in potential is meaningful, so where to choose $V=0$ is arbitrary

$$V_{ba} = V_b - V_a = \frac{PE_b - PE_a}{q} = -\frac{W_{ba}}{q}$$

+q has high PE in a
- q has high PE in b

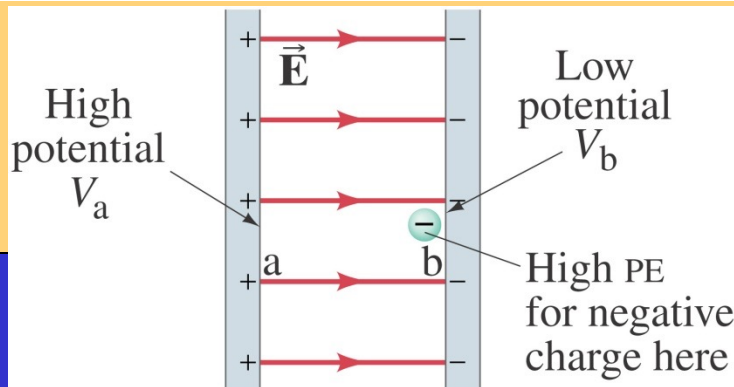

V is due to charges on the plates
V is high on + side
V is low on - side

Electric Potential vs. Potential Energy

Analogy between gravitational and electrical potential energy:

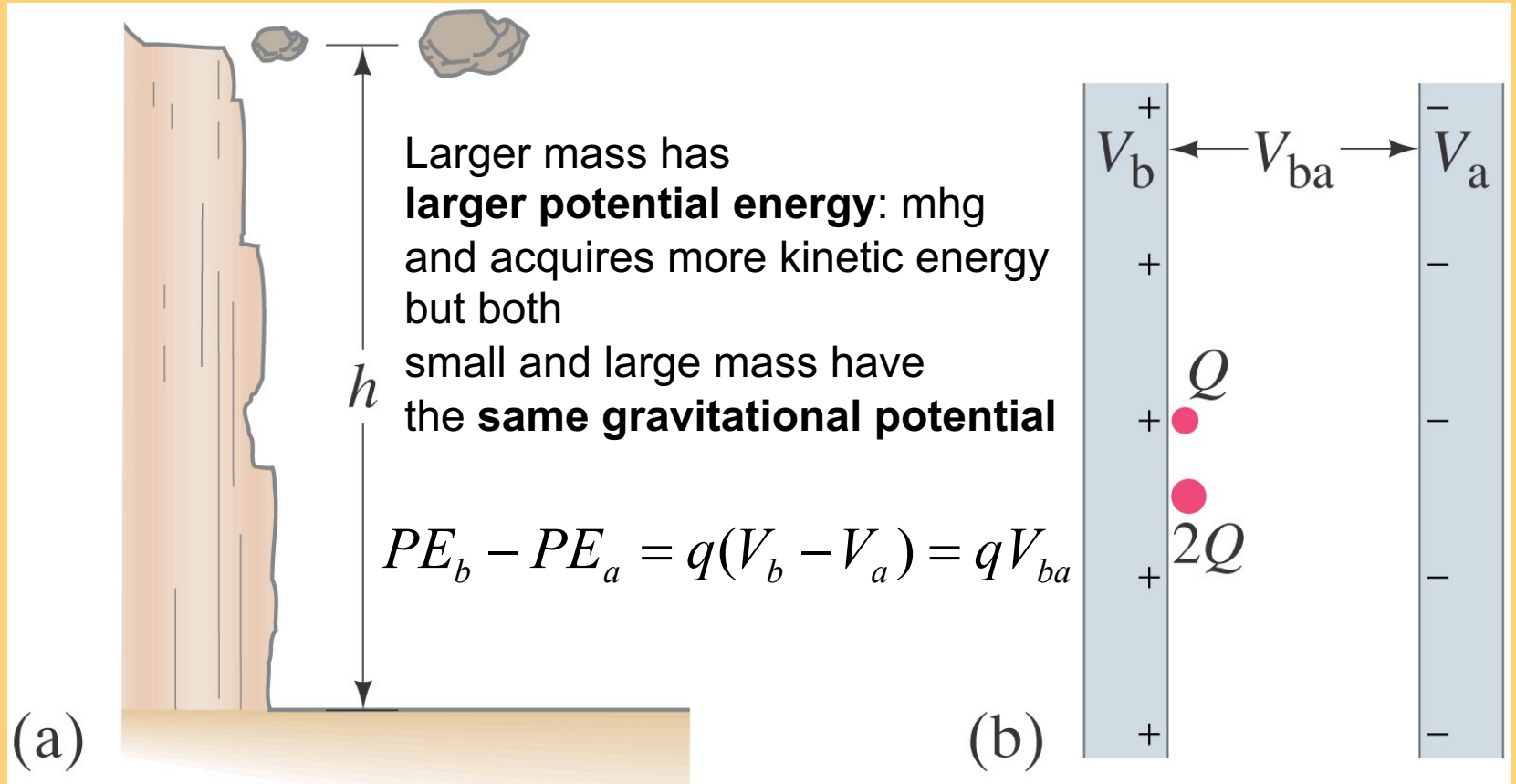

Gravitational PE depends on both m and h . g - effects of h . g depends on planet
 Electrical PE depends on both Q and V_{ab} - effects of V_{ab} depends on charges on plates

Batteries, electric generators – keep potential difference

Exercise

Ex. 17-2 Suppose an electron is accelerated from rest through a potential difference $V_b - V_a = V_{ba} = +5000 \text{ V}$. (a) What is the change in electric potential energy of the electron? (b) What is the speed of the electron as a result of this acceleration? $m_e = 9.1 \times 10^{-31} \text{ kg}$

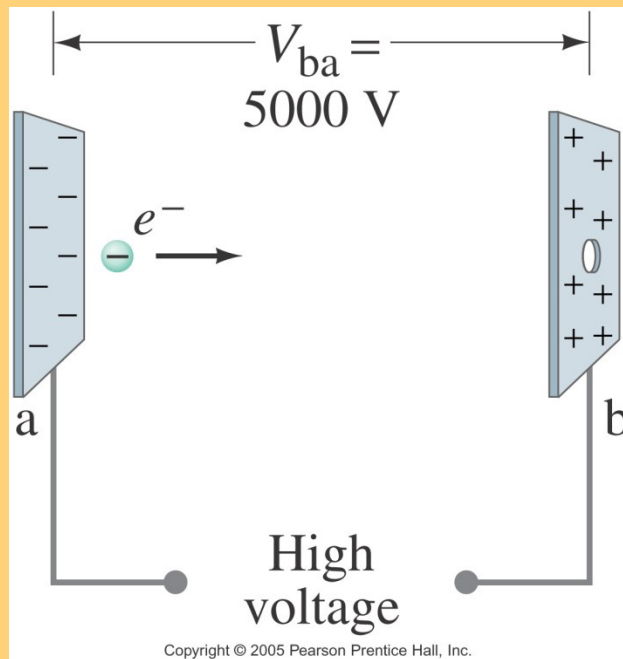

$$\Delta PE = qV_{ba} = -8.0 \times 10^{-16} \text{ J}$$

$$\Delta KE = -\Delta PE \Rightarrow v = 4.2 \times 10^7 \text{ m/s}$$

Proton would be accelerated from rest by a potential difference -5000 V

$$m_p = 1.67 \times 10^{-27} \text{ kg}$$

Electric Potential and Field

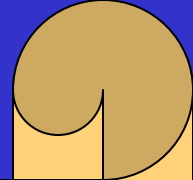

Work is charge multiplied by potential difference: $W = -q(V_b - V_a) = -qV_{ba}$

Work is also force multiplied by distance: $W = Fd = qEd$

Solving for the field,

$$E = -\frac{V_{ba}}{d}$$

Unit: **N/C** or **V/m**

*Signs tells us that the electric field points in the direction of **decreasing** potential V*

E is VECTOR
V is SCALAR

Ex. 17-3 Two parallel plates are charged to produce a potential difference of 50 V. If the separation between the plates is 0.050 m, calculate the magnitude of the electric field in the space between the plates

$$E=1000 \text{ V/m}$$

If the field is not uniform, it can be calculated at multiple points:

$$E_x = -\Delta V / \Delta x$$

Equipotential Lines

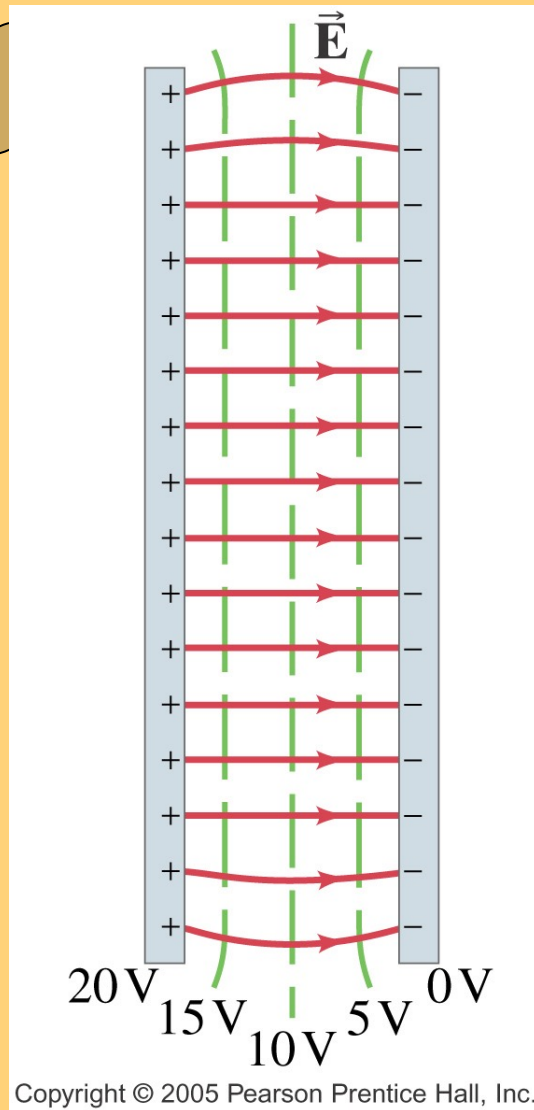

An **equipotential** is a line or surface over which the **potential is constant**.

Electric field lines are **perpendicular** to equipotentials.

A conductor is entirely at the same potential in the static cases; the surface of a conductor is an equipotential.

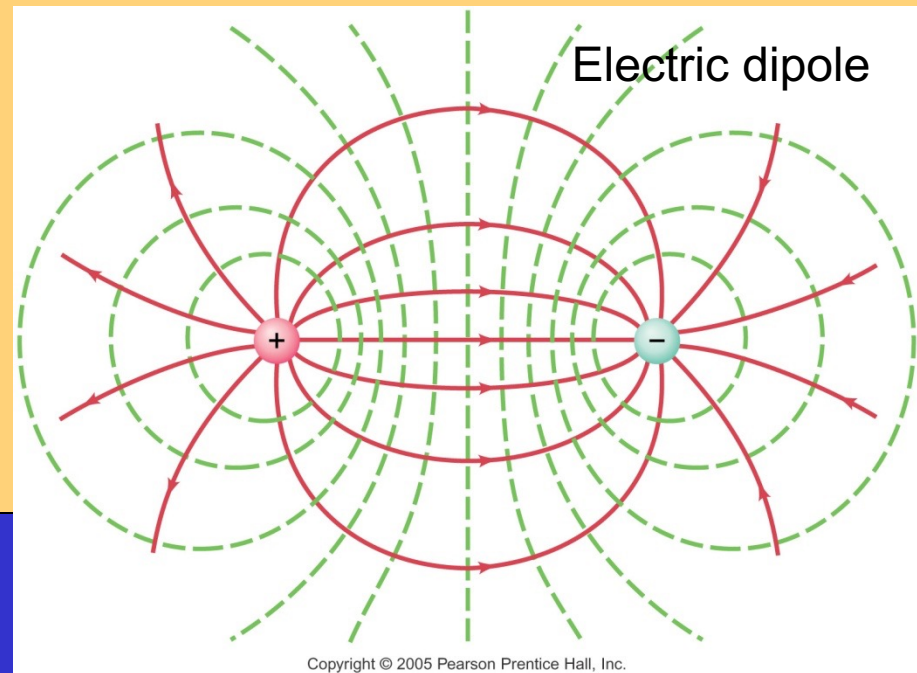

Similar to topographic maps

Electric Potential

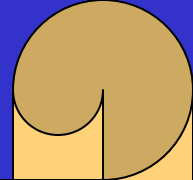

The **electric potential** due to a *point charge* can be derived using calculus.

$$E = k \frac{Q}{r^2}$$

$$V = k \frac{Q}{r}$$
$$= \frac{1}{4\pi\epsilon_0} \frac{Q}{r}$$

Potential in this case is taken to be zero at infinity

$$1 \text{ eV} = 1.6 \times 10^{-19} \text{ J}$$

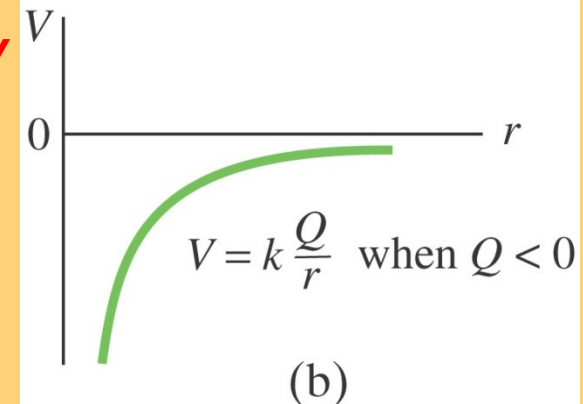
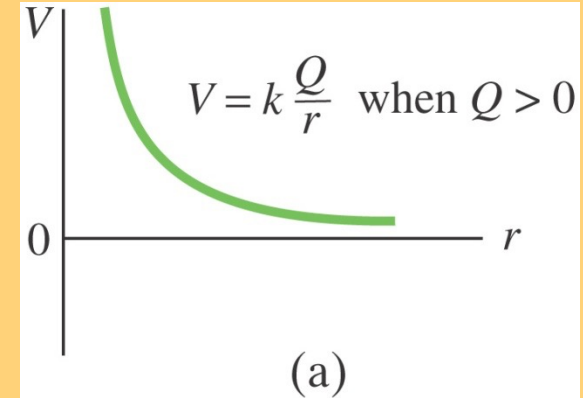

Copyright © 2005 Pearson Prentice Hall, Inc.

NOTE: Joule is a very large unit for dealing with energies of electrons, atoms or molecules, this is why eV was introduced. One electron volt (eV) is the energy gained by an electron moving through a potential difference of one volt.

Exercises

$$V = k \frac{Q}{r}$$

$$W = -q(V_b - V_a)$$

E is VECTOR; V is SCALAR

Ex. 17-4 Determine the potential at a point 0.50 m (a) from a $+ 20\mu\text{C}$ point charge, (b) from a $- 20\mu\text{C}$ point charge
(a) $3.6 \times 10^5\text{V}$ (b) $-3.6 \times 10^5\text{V}$

Ex. 17-5 What minimum work must be done by an external force to bring a charge $q = 3.00\mu\text{C}$ from a great distance away (r : infinity) to a point 0.500 m from a charge $Q = 20.0\mu\text{C}$?
1.08 J

NOTE:

To find the electric field near a collection of two or more point charges requires adding VECTORS

To find the electric potential near a collection of two or more point charges is EASIER, it only requires adding NUMBERS

NOTE:

Take the **sign** of the charge into account when calculating electric potential

Exercise

$$V = k \frac{Q}{r}$$

$$W = -q(V_b - V_a)$$

E is VECTOR; V is SCALAR

Ex. 17-6 Calculate the electric potential (a) at point A and (b) at point B

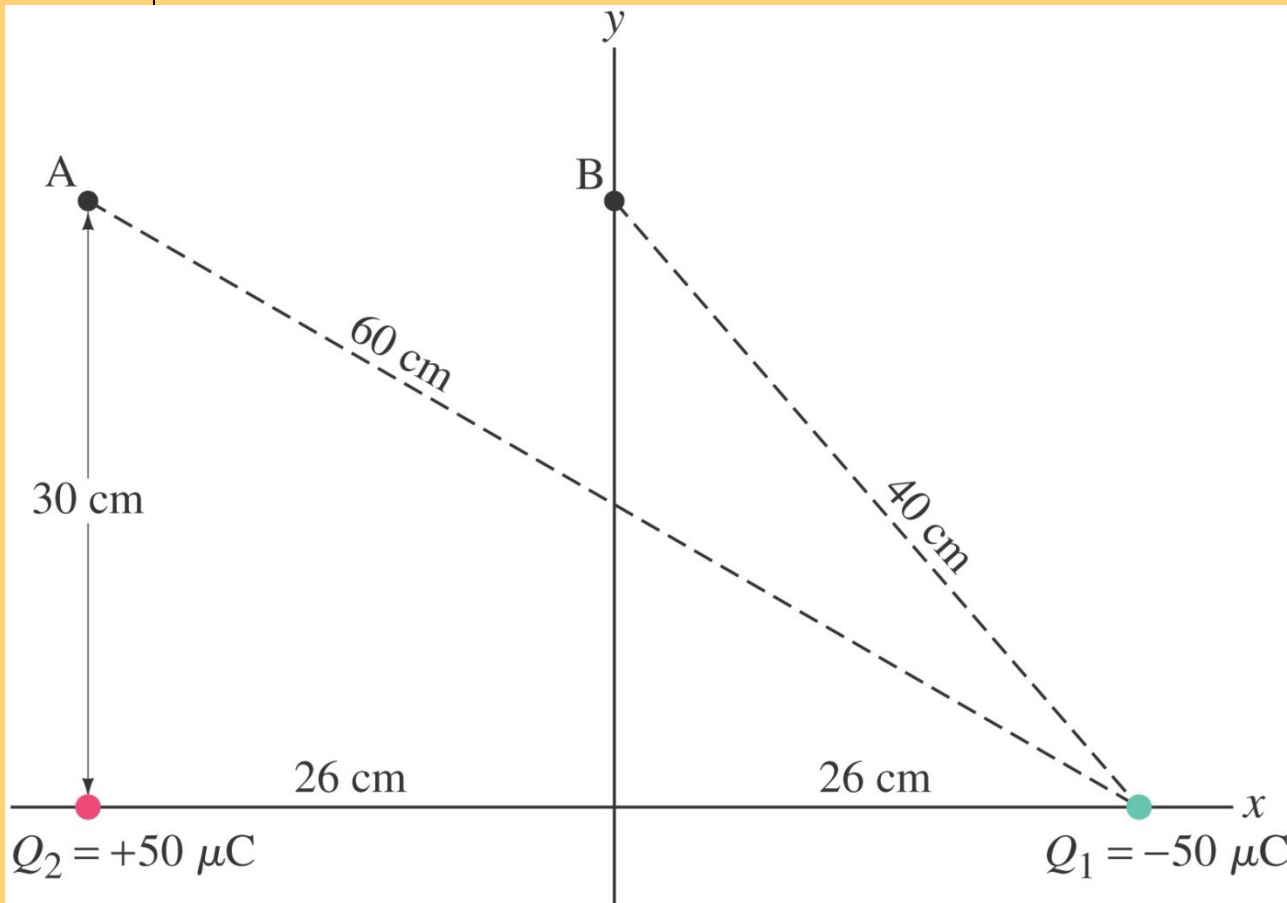

$$(a) V_a = 7.5 \times 10^5 V$$

$$(b) V_b = 0$$

Electric Potential Energy of a System of Point Charges

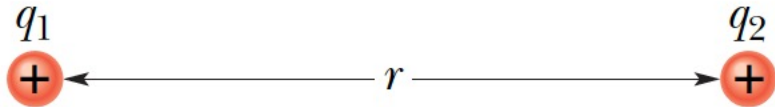

Potential created by q_1 at a distance r

$$V = \frac{1}{4\pi\epsilon_0} \frac{q_1}{r}$$

Potential ENERGY of q_2

$$PE = W = q_2 V = \frac{1}{4\pi\epsilon_0} \frac{q_1 q_2}{r}$$

This is also the work done by an EXTERNAL force to bring q_2 from an infinity to a distance r from particle q_1

Capacitance

A capacitor is a device that can **store** electric charge. It consists of two conductors that are close but not touching.

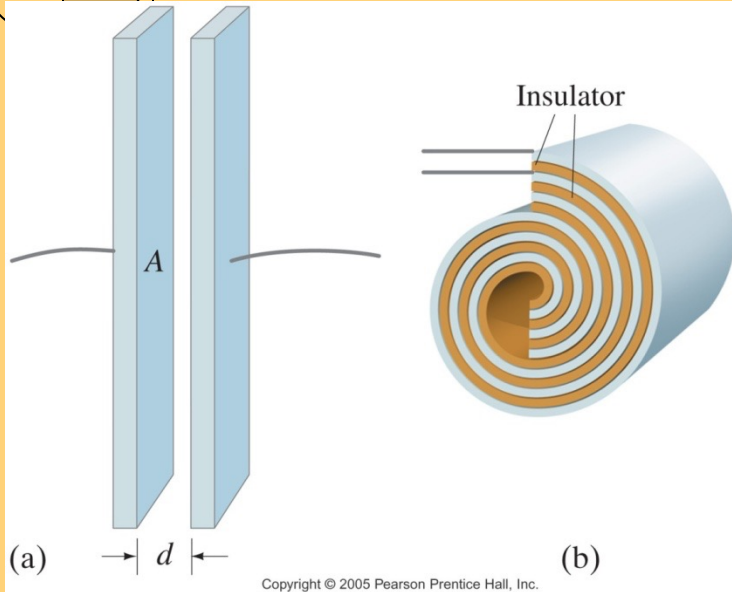

Capacitor connected to a battery:
charge on its plates is proportional
to the voltage:

$$Q = CV$$

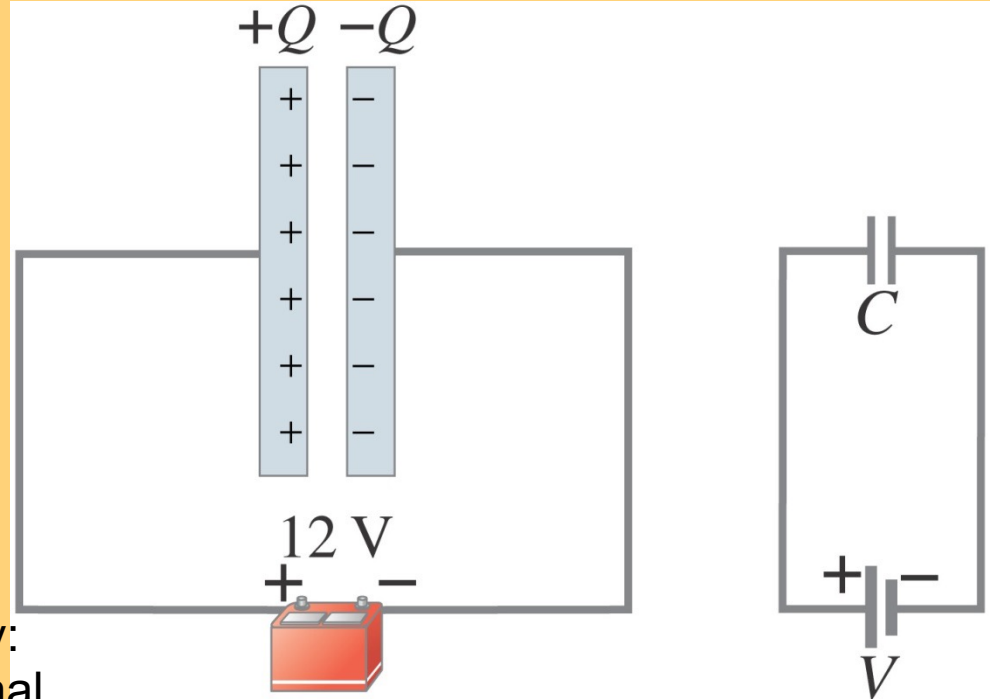

The quantity C is called the capacitance.

Unit of capacitance: the farad (F)

$$1 \text{ F} = 1 \text{ C/V}$$

Examples of capacitors: power backups, camera flash

Capacitance

$$Q = CV$$

Common capacitors have capacitance in the range of 1 pF to $10^3 \mu\text{F}$

$$1\text{pF} = 10^{-12}\text{F}$$

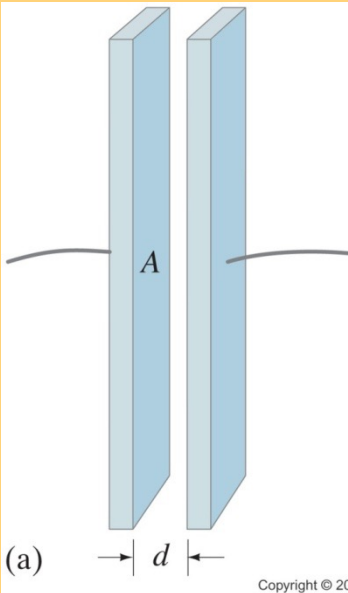

From here on V indicates potential difference

In general, C does not depend on Q or V
For a parallel-plate capacitor:

$$C = \epsilon_0 \frac{A}{d}$$

Ex. 17-8 (a) Calculate the capacitance of a parallel-plate capacitor whose plates are 20 cm x 3.0 cm and are separated by a 1.0-mm air gap. (b) What is the charge on each plate if a 12-V battery is connected across the two plates? (c) What is the electric field between the plates? (d) Estimate the area of the plates needed to achieve a capacitance of 1 F, given that the same air gap d.

(a) 53pF (b) $6.4 \times 10^{-10}\text{C}$ (c) $1.2 \times 10^4\text{V/m}$ (d) $A \approx 10^8\text{m}^2$

$$\epsilon_0 = \frac{1}{4\pi k} = 8.85 \times 10^{-12}\text{C}^2/\text{N}\cdot\text{m}^2$$

Dielectrics

A dielectric is an insulator, and is characterized by a dielectric constant K .

Capacitance of a parallel-plate capacitor filled with dielectric:

$$C = K\epsilon_0 \frac{A}{d}$$

Purpose of dielectrics:

- (i) They do not break (=charge flow) as easily as in air; higher voltage can be applied
- (ii) Plates can be together without touching; C increases as d decreases
- (iii) They increase C by K

Permittivity of the material $\epsilon = K\epsilon_0$

Ex. 17-9 An airfilled capacitor consisting of 2 parallel plates separated by a distance d is connected to a battery of voltage V and acquires a charge Q . While it is still connected to the battery, a slab of dielectric material with $K=3$ is inserted between the plates of the capacitor. Will Q increase, decrease, or stay the same?

V stays constant, C increases, so Q increases as well

Ex. 17-10 Suppose the capacitor above is instead disconnected from the battery and then a dielectric is inserted between the plates. Will Q , C , or V change?

Q stays constant, C increases, so V decreases

Storage of Electric Energy

A charged capacitor stores electric energy; the energy stored is equal to the work done to charge the capacitor.

$$\Delta W = V\Delta q \Rightarrow W = \frac{V_f}{2} Q$$

$$PE = \frac{1}{2} QV = \frac{1}{2} CV^2 = \frac{1}{2} \frac{Q^2}{C}$$

Ex. 17-11 A camera flash unit stores energy in a 150-mF capacitor at 200 V. How much electric energy can be stored?

$$PE = 3.0 \text{ J}$$

For parallel plates $C = \epsilon_0 \frac{A}{d} \Rightarrow PE = \frac{1}{2} CV^2 = \frac{1}{2} \epsilon_0 E^2 Ad$

$$\text{energy density} = \frac{PE}{\text{volume}} = \frac{1}{2} \epsilon_0 E^2$$

This is true for any region, **not just** parallel plates